

UNI-T®

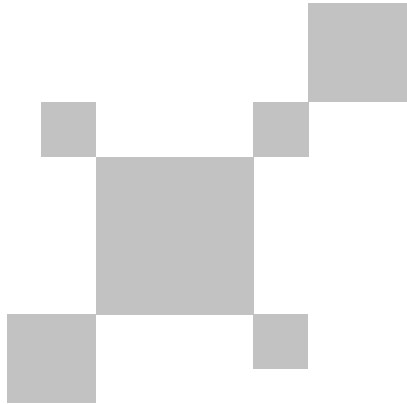

UTi740H
Professional Thermal Imager
User Manual

P/N:110401111504X

PREFACE

Thank you for purchasing the new UTi740H thermal imager. In order to use this product safely and correctly, please read this manual thoroughly, especially the Cautions part. After reading this manual, it is recommended to keep the manual at an easily accessible place, preferably close to the device, for future reference.

LIMITED WARRANTY AND LIABILITY

Uni-Trend guarantees that the product is free from any defect in material and workmanship within one year from the purchase date. This warranty does not apply to damages caused by accident, negligence, misuse, modification, contamination and improper handling. The dealer shall not be entitled to give any other warranty on behalf of Uni-Trend. If you need warranty service within the warranty period, please contact your seller directly.

This warranty is the only compensation you can obtain. Uni-Trend will not be responsible for any special, indirect, incidental or subsequent damage or loss caused by any reason or speculation. As some areas or countries do not allow limitations on implied warranties and incidental or subsequent damage, the above limitation of liability and stipulation may not apply to you.

CAUTIONS

1. Use or store the product at specified operating or storage temperatures. Otherwise, the device may be damaged.
2. Do not directly aim the product at high-intensity thermal radiation sources, such as the sun, laser device, spot-welder, etc.
3. Do not knock, toss, or shake the product and accessories.
4. Do not place the battery in a high temperature environment or near high temperature objects. Do not short-circuit the positive and negative electrodes of the battery. Do not place the battery in a humid environment or water.
5. Do not expose the device to dusty or damp environment. When used in an environment with water, avoid water splashing on the product.
6. Do not use dissolved or similar liquids on the product or cables, as it may cause device damage.
7. Please follow the following instructions when wiping the device:
 - Non-optical surface: If necessary, use a clean and soft cloth to wipe the non-optical surface of the thermal imager.
 - Optical surface: Do not stain the optical surface of the lens when using the thermal imager. Be especially careful not to touch the lens with hands, as sweat from hands will leave marks on the lens glass and may erode the optical coating layer on the glass surface. When the optical surface is stained, carefully wipe it with a special lens paper.
8. When using the device, please try to keep it stable and avoid violent shaking.
9. Please close the lens cover and put the product and its accessories into the carrying box when it is not used.
10. Please do not disassemble the device to avoid product damage and loss of warranty rights.
11. Due to different batches, the materials and details of actual products may be slightly different from the graphic information. Please refer to the goods received.
12. The experimental data in the manual are theoretical values and all from Uni-Trend's internal laboratories, for reference only. Customers cannot use them as bases for placing orders. If users have any questions, please contact customer service.

TABLE OF CONTENTS

1. Specifications	4
2. Product Structure	5
3. LCD Indicators/Icons	6
4. Power on/off	6
5. Main Menu	7
6. Submenu	7
7. Settings	9
8. Image Browsing and Editing	10
9. Digital Zoom	10
10. SD Card	11
11. Maintenance	11
12. Notes	14
13. Emissivity Table	12

1. Technical Specifications

Sensor	Uncooled vanadium oxide
Mode	Auto gain
Temperature measurement range	-30°C~650°C (-22°F~1202°F)
Accuracy	Target temperature: -10°C~650°C, ambient temperature: 25°C, accuracy: ±2°C/±2% (whichever is greater)
Optimal measurement distance	1m
Emissivity	0.95 (default) 0.01~1.00
Pixel size	17µm
IR resolution	384 x 288 (110592)
Digital camera resolution	5MP (auto focus)
Color palettes	Red Hot, Rainbow HC, Rainbow, Lava, Ironbow, Black Hot, White Hot
Spectral range	8~14µm
Field of view (FOV)	28°x 21°
Spatial resolution (IFOV)	1.3mrad
Lens focal length	13mm
Focus	Manual focus
Thermal sensitivity (NETD)	< 60mK@25°C
Frame rate	25Hz
Digital zoom	1X, 2X, 4X
On screen analyzer	5 Points/1 Line/5 Rectangles/5 Circles (up to 6 graphics can be added)
Isotherm	Manual/Auto
Temperature mark	Center spot, Hi/Lo spot
Temperature unit	°C (default)/°F
Hi/Lo temperature alert	√ (LCD animation)
Image modes	Thermal, Visual image, Fusion (T-Mix), PIP
Camera mode	Photo capturing

Image storage format	BMP
Image browsing	Temperature analysis, change palettes, annotations
USB communication	Type-C USB (Live video and USB disk storage)
Wi-Fi	√
PC screen projection	√
PC analysis software	√ (real-time image transmission, photo download and analysis)
Smartphone APP	√ (photo download and analysis)
Certificates	CE, UKCA, FCC, RoHS
Languages	English/German/French/Italian/Spanish/Swedish
Operating temperature	-10°C~50°C (14°F~122°F)
Storage temperature	-20°C~60°C (-4°F~140°F)
Operating humidity	10%~95%RH, non-condensing
Operating time	About 5h
Charging time	< 5h
Charging voltage/current	5V/2A
IP rating	IP54
Drop proof	2m

2. Product Structure

1. Type-C USB interface
2. SD card slot
3. Power
4. OK
5. Left
6. Down
7. LCD
8. Up
9. Image browsing
10. Return
11. Right
12. Battery pack
13. Bracket screw hole
14. Focusing ring
15. Hand strap hole
16. Trigger
17. Visual light camera lens
18. Infrared camera lens

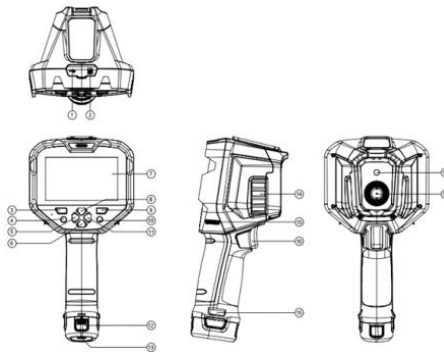

3. LCD Indicators/Icons

Display size: 4.3" IPS

Display resolution: 480 (vertical) × 800 (horizontal)

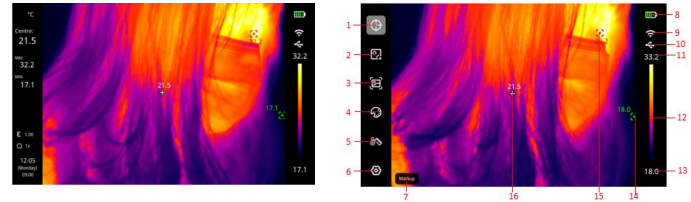

Item	Description	Item	Description
1	Temperature mark	9	Wi-Fi
2	On screen analyzer	10	USB
3	Image modes	11	Temperature range upper value
4	Color palettes	12	Range bar
5	Isotherm	13	Temperature range lower value
6	Settings	14	Lo spot
7	Menu bar text	15	Hi spot
8	Battery status	16	Center spot

4. Power on/off

Long press Power button for 5s to turn on thermal imager (it needs 30 minutes warm-up time when the device is just turned on or not used for a long time, or the measurement environment changes). Long press Power button for 3s, "Shutdown?" will show on the screen. Select "OK" to turn off thermal imager. Long press Power button for 8s to power off directly.

When the battery is low, a low battery indicator will show on the screen, which means the thermal imager should be turned off and the battery should be charged. When the thermal imager is in low battery status for a long time, it will automatically shut down.

5. Main Menu

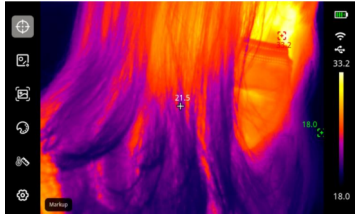

In the main interface:

1. Press OK button to open the main menu.
2. Press Up/Down button to step through the submenu.
3. Press OK button to open the selected submenu.
4. In the submenu, press Up/Down button to select an option.
5. Press OK button to confirm and save the selection.
6. Press Return button to return to the previous interface.

6. Submenu

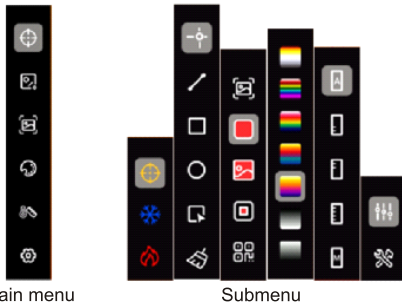

Temperature mark	Display/hide Center spot, Hi/Lo spot
On screen analyzer	Add Point, Line, Rectangle, Circle
Image modes	Select between Thermal, Visual image, Fusion, PIP (T-Mix) or add QR codes
Color palettes	Switch between Red Hot, Rainbow HC, Rainbow, Lava, Ironbow, Black Hot, White Hot
Isotherm	Switch between Auto, Below, Above, Section, Manual
Settings	Set the parameters and the system settings

6.1 On Screen Analyzer

After adding an analysis object, a "Choose" submenu will appear. The optional functions in the submenu are Move, Stretch (this function cannot be applied to point objects), Difference (point objects can only be compared with point objects; the difference between the MAX/MIN/AVG temperature of two comparison objects will be displayed on the left side), Delete (delete the selected object). The temperature information of the added analysis object will be displayed on the right side.

When there are analysis objects in the main interface, select "Choose" and press the direction buttons to select an analysis object. A secondary menu will pop up, select "Difference" in it, and press the OK button. Press the direction buttons to select another object to be compared. The comparison information will be displayed on the left side (The comparison can be canceled in the secondary menu).

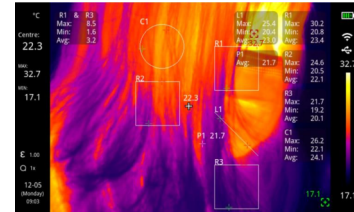

6.2 QR Code

Users can manually input or scan the QR code. Select "Cancel" to return to the main interface. After a QR code is input or scanned, it can be saved to a classified folder. (Note: The QR code cannot exceed 100 characters.)

The QR code is added to classify the images and make it easier for users to find the images quickly. If the added QR code is saved in an existing classified folder (QR1, QR2, QR3, QR4 or QR5), the images marked with this QR code can be browsed in the corresponding folder. QR codes saved in folder "Others" are temporary and will not be saved to the existing folders.

If the QR code is manually input, the interface for selecting QR code files will pop up. There are several options: QR codes in the existing classified folders (QR1, QR2, QR3, QR4 and QR5), other QR codes (added and used QR codes), input new QR codes. When "Input new QR codes" is selected, a keyboard will pop up. After customizing the QR code name, the interface for selecting the storage location of the new QR code will pop up. The optional folders are: QR1, QR2, QR3, QR4, QR5 and Others (temporary location).

7. Settings

7.1 Parameter Settings

In the setting interface of parameters, Emissivity, Object distance, Ambient temperature, Reflected temperature and Relative humidity can be set.

- 1) Please refer to the emissivity table.
- 2) If users are not sure which values to choose, it is recommended to use the default values:
 Emissivity: 0.95
 Object distance: 1.0m
 Ambient temperature: 25°C
 Reflected temperature: 25°C
 Relative humidity: 45%RH

Note: Emissivity and Reflected temperature are the two most important parameters. If in doubt, use the default values.

7.2 System Settings

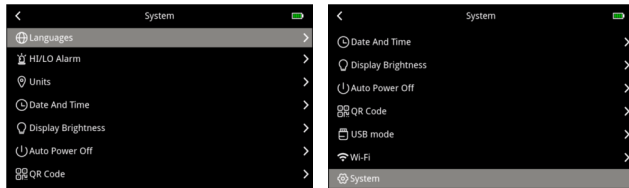

Languages	English/German/French/Italian/Spanish/Swedish are selectable
Hi/Lo temperature alert	Enable the Hi/Lo temperature alert (When the measured temperature exceeds the Hi value, a red triangle will pop up. When it is lower than the Lo value, a green triangle will pop up.)
Units	Change the temperature unit (°C, °F) and distance unit (m, ft)
Date/Time	Change the time format, date, time
Display brightness	Adjust the brightness (high, medium, low)
Auto power off	Enable or disable the auto power off function (30min, 15min, 5min)
QR code	Modify the name of the classified folder and the value of its corresponding QR code
USB modes	Select between USB disk mode and Live video mode
Wi-Fi	Turn on/off the Hotspot and modify the Hotspot information when it is on (Note: The password cannot be less than 8 digits.)
System	View product information: Product model, IR resolution, firmware version, software version, (SD card) capacity, (SD card) remaining capacity Factory reset: Restore factory settings

8. Image Browsing and Editing

In the main interface, press the Image Browsing button to enter the multimedia browsing interface.



Image information	View the image name, capture date, modified date, IR resolution, emissivity, Hi spot temperature, Lo spot temperature, center spot temperature, remarks
Image editing	Edit the image: Temperature mark, On screen analyzer, Image modes, Color palettes, Isotherm
Image notes	Add text notes to the image, which can be viewed in the image information
QR code	Change the classified folder of the QR code, browse the image with the QR code added in the corresponding folder, and delete the existing QR code of the current image
Delete	Delete the current image

9. Digital Zoom

In the main interface, press Up/Down button to zoom in the screen. The current magnification is displayed on the left side of the screen. The magnification steps through 1X, 2X, 4X and 1X.

10. SD Card

The device can be inserted into a Micro SD card to store images. To avoid affecting the device operating speed, please copy the backup data regularly and clean up the SD card in time. Do not insert or remove the SD card repeatedly when the device is turned on; otherwise the data in it may be abnormal. If the SD card is removed when users are browsing or editing images, a prompt "No SD Card" will pop up.

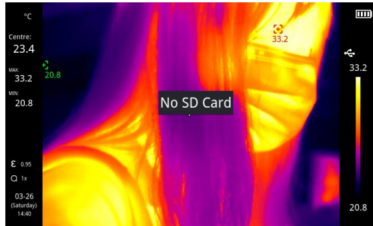
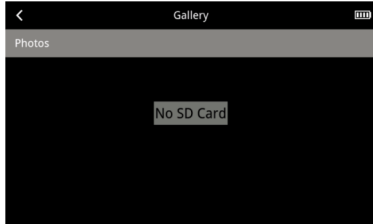

11. Maintenance

Use a wet cloth or weak soap solution to clean the outer housing of the device. Do not use abrasives, isopropyl alcohol or solvents to clean the housing or lens.

12. Notes

This equipment has been tested and found to comply with the limits for a Class A digital device, pursuant to part 15 of the FCC Rules. These limits are designed to provide reasonable protection against harmful interference when the equipment is operated in a commercial environment. This equipment generates, uses, and can radiate radio frequency energy and, if not installed and used in accordance with the instruction manual, may cause harmful interference to radio communications. Operation of this equipment in a residential area is likely to cause harmful interference in which case the user will be required to correct the interference at his own expense.

If this equipment does cause harmful interference to radio or television reception, which can be determined by turning the equipment off and on, the user is encouraged to try to correct the interference by one or more of the following measures:

- Reorient or relocate the receiving antenna.
- Increase the separation between the equipment and receiver.
- Connect the equipment into an outlet on a circuit different from that to which the receiver is connected.
- Consult the dealer or an experienced radio/TV technician for help.

Changes or modifications to this unit not expressly approved by the party responsible for compliance could void the user's authority to operate the equipment.

13. Emissivity Table

Material	Emissivity	Material	Emissivity
Wood	0.85	Black paper	0.86
Water	0.96	Polycarbonate	0.8
Brick	0.75	Concrete	0.97
Stainless steel	0.14	Copper oxide	0.78
Tape	0.96	Cast iron	0.81
Aluminum plate	0.09	Rust	0.8
Copper plate	0.06	Gypsum	0.75
Black aluminum	0.95	Paint	0.9
Human skin	0.98	Rubber	0.95
Asphalt	0.96	Soil	0.93
PVC	0.93		

Contents of this manual are subject to change without prior notice.

UNI-T®**UNI-TREND TECHNOLOGY (CHINA) CO., LTD.**

No. 6, Gong Ye Bei 1st Road,
Songshan Lake National High-Tech Industrial
Development Zone, Dongguan City,
Guangdong Province, China